

GLASS THICKNESS 8-10mm

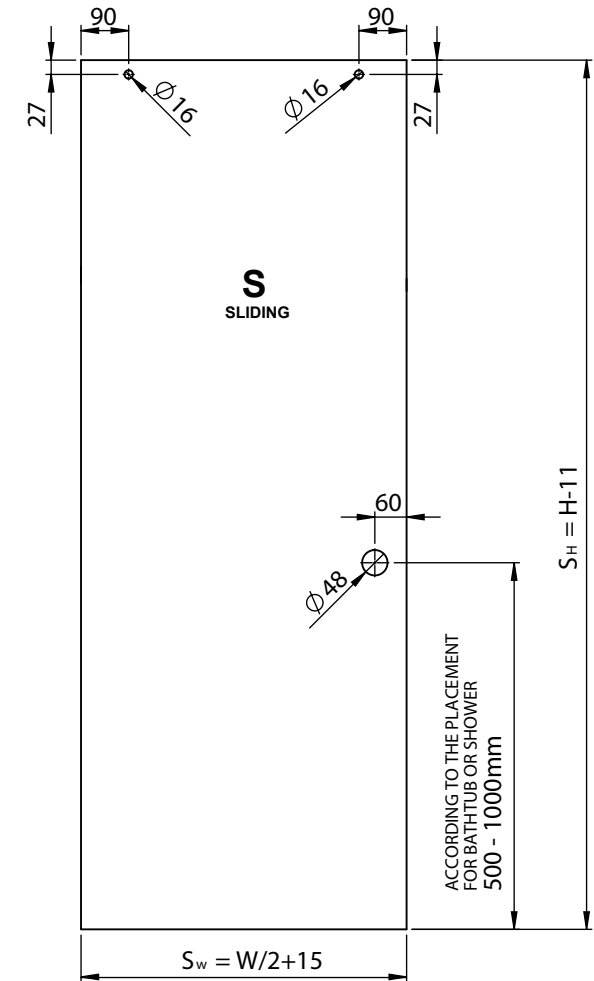
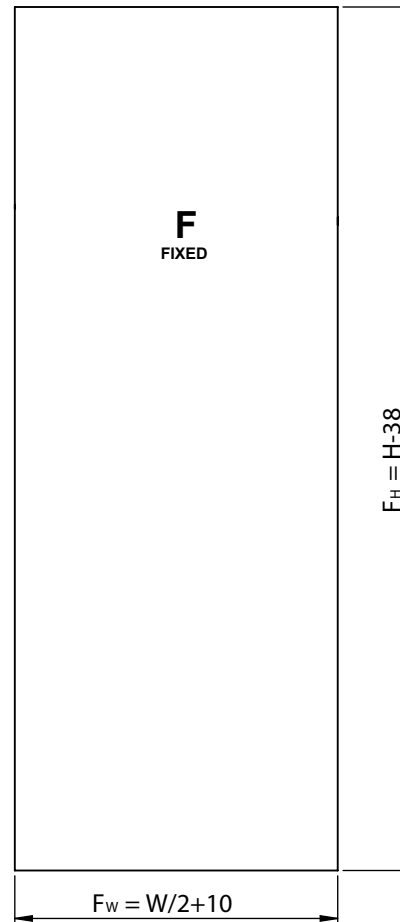
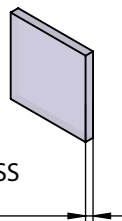

**IMPORTANT INSTRUCTIONS**

- The gaps have already computed in given dimensions. The glass have space 5mm from the wall and 3mm from the frame.
- Install the silicon sealants to the required edges according to the glass thickness.
- If the glass will ordered with processed surface, careful about the correct side of glass.
- The installation of the showering system require leveled walls and floor.

*Shower system in straight line, with one sliding door and one fixed glass panel.*

# GS-R10

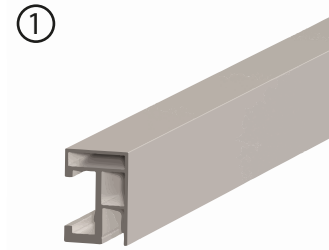
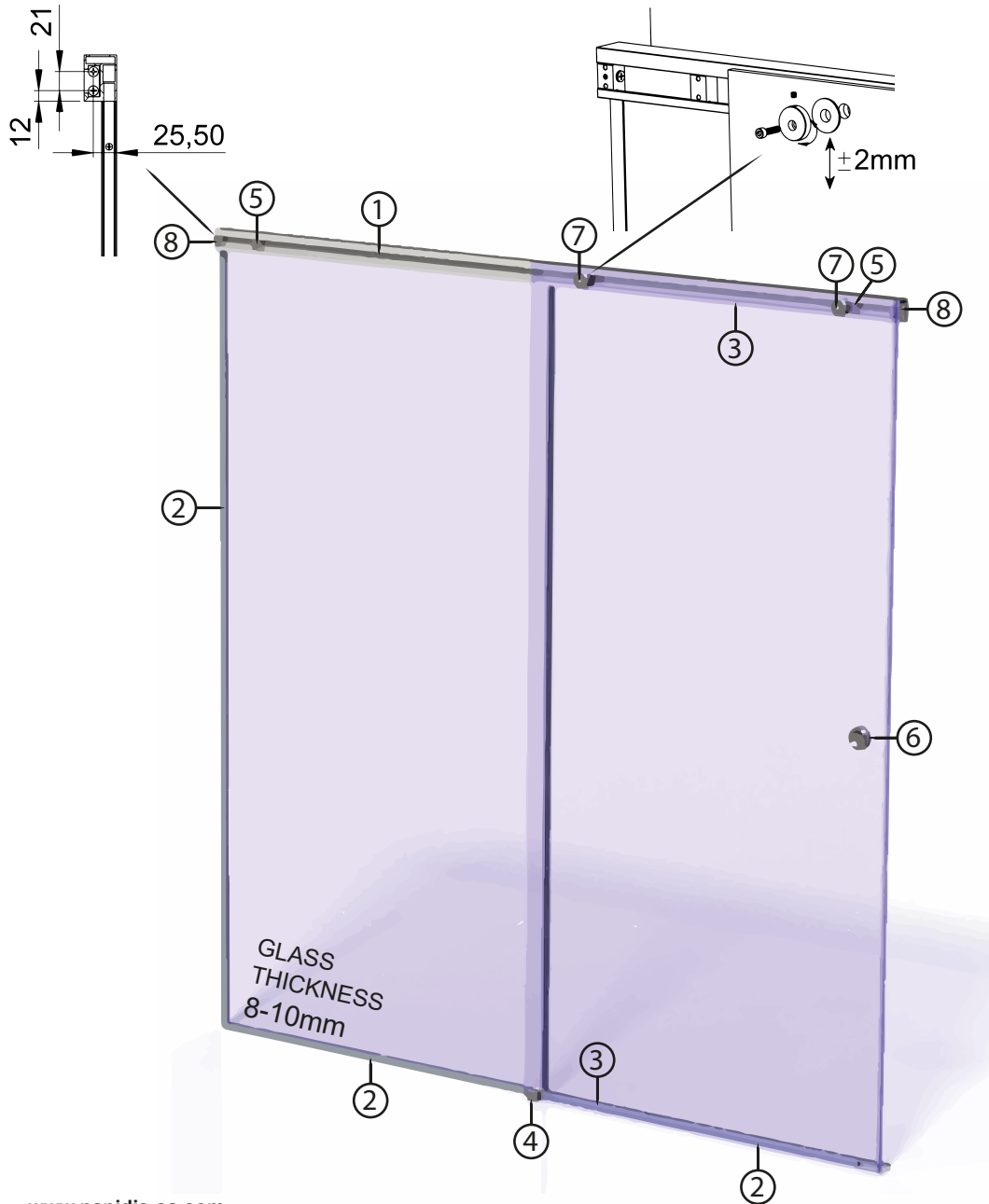

GS-R10-101

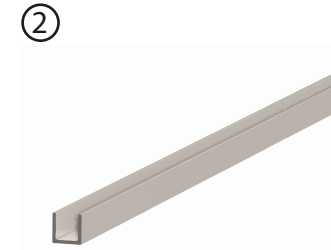

3 x GS-R10-106

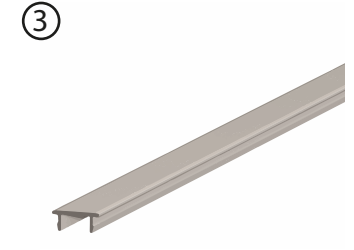

2 x GS-R10-105

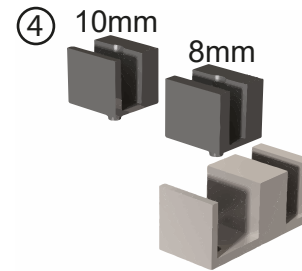

GS-R10-400

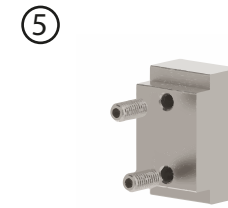

2 x GS-R10-104

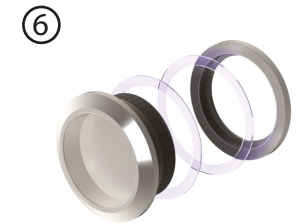

GS-R10-300

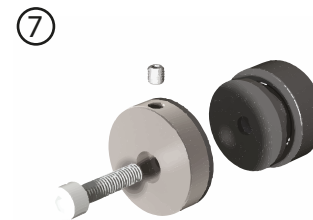

2 x GS-R10-200

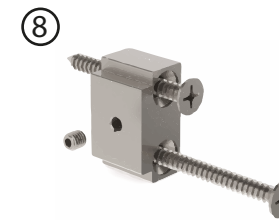

2 x GS-R10-110